



Description

Alloy Thermal-Link / Alloy Thermal Cutoff (ATCO) is defined as a non-resettable protective device functioning one time only. It is widely used in electrical equipment. ATCO is mainly consist of fusible alloy, flux resin, case, sealant and lead wires. Normally, fusible alloy is jointed to the two lead wires. Under abnormal conditions, when the temp. reaches to the fusing temp. of ATCO, the fusible alloy melts and quickly retracts to the two lead wire ends with the aid of the flux resin and disconnects the circuit completely.

SETsafe | SETfuse Alloy Thermal-Link (ATCO) CR series Rated Functioning Temp. 139 °C, Rated Current: 15 A, safety certification Includes UL, cUL, TUV, and complies with RoHS and REACH.

Features

- Non-Resettable
- High Accuracy of Functioning Temp.
- RoHS & REACH Compliant

Applications

- Lamps
- Switched-Mode Power Supplies
- Home Electrical Appliances
- Transformers
- Motors
- Power Strips

Customization

- Other Temp.
- The Length of Lead Wires
- Taping Packing Available
- Lead Wires can be Insulated
- Tinned Copper Wires or CP Wires
- Leads Forming Types

Structure Diagrams

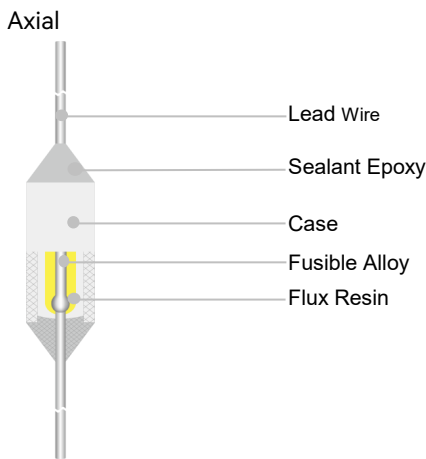

Marking

Axial (Color for reference only)

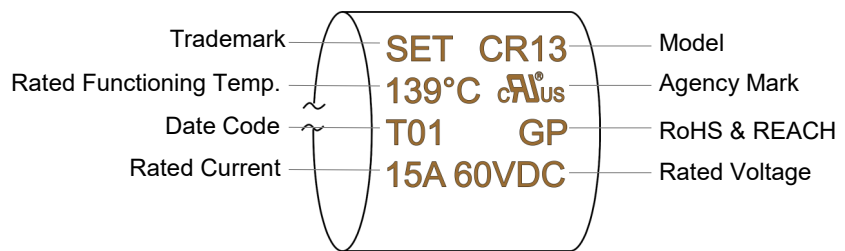

Remark: The first letter of the Date Code Year/quarter A stands for 2000, B stands for 2001, 01 stands for the first quarter, 02 stands for the second quarter, and so on.

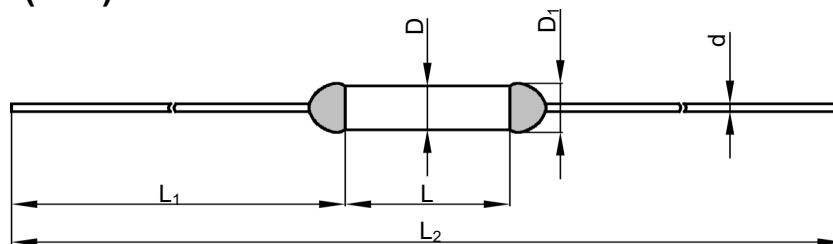

Dimensions (mm)



L	L ₁	L ₂	D	D ₁	d
11.5 ± 0.5	34.0 ± 2.0	79.5 ± 3.0	3.3 ± 0.5	≤ 3.8	1.00 ± 0.05

Specifications



Rated Functioning Temp. (T_f) °C

139	Model	Fusing Temp.	T_h	T_m	I_r	U_r	I_n 8 / 20 μ s (15 Times)	I_{max} 8 / 20 μ s (1 Time)				RoHS REACH
		(°C)	(°C)	(°C)	(A)	(V)	(kA)	(kA)	UL	cUL	TUV	
	CR13	135 ± 2	85	200	15	DC 60	6	12	●	●	●	●

Note:

- 1: "●"Means certificated, "○"Means non-certificated, RoHS & REACH Compliant .
- 2: " * "Customizable DC voltage.

Agency Information

Institution	Standards	The File No. and certification No. obtained by SETsafe SETfuse
	UL 60691	E214712
	CAN-CSA-E60691	E214712
	EN 60691	R50415812

Soldering

Hand-Soldering

- Soldering should be carried out according to Table T-1.
- The thermal element of ATCO is fusible alloy with low melting point, which is jointed with ATCO lead wires. Improper soldering operation (too high soldering temp. , too long soldering time, too short lead wire etc.) may transfer more heat to the thermal element and ATCO may open in advance.
- When soldering conditions are more severe than those listed in Table T-1, a heat sink fixture should be used between soldering point and ATCO body.
- When soldering, please do not pull / push or twist ATCO body or lead wires.
- After soldering, let it naturally cool for longer than 20 seconds. During cooling, never move the ATCO body or lead wires.

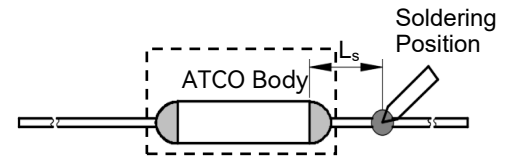

FIGURE T-1

TABLE T-1 Hand-Soldering Time

Rated Functioning Temp. (T_f)	Max. Allowable Soldering Time for Different Lead Wire Length (Fig.T-1)									Max. Soldering Temp.
	L_s Length	Time		L_s Length	Time		L_s Length	Time		
		Tinned Copper Wire	CP Wire		Tinned Copper Wire	CP Wire		Tinned Copper Wire	CP Wire	
(°C)	(mm)	(s)	(s)	(mm)	(s)	(s)	(mm)	(s)	(s)	(°C)
139	10	3	6	20	5	8	30	5	8	400

Note:

a: Auxiliary Heat Sink Fixture is Required to Avoid ATCO Cutting off Unexpectedly.

Wave Soldering

The wave soldering parameters as Table T-2, for reference only, when ATCO is for practice use, you need to do some validation experiments. For example, using X-RAY to see the fusible alloy of ATCO whether damage after wave soldering.

TABLE T-2 Wave Soldering Parameters Setting

Rated Functioning Temp. (T_f)	Max. Allowable Preheating Temp. When the Length of Lead Wire is Different (Fig.T-1)				Preheating Time (t_1)	Max. Wave Soldering Temp.	Dwelling Time (t_2)	Cooling Time (t_3)
	L_s Length	Preheating Temp.	L_s Length	Preheating Temp.				
(°C)	(mm)	(°C)	(mm)	(°C)	(s)	(°C)	(s)	(s)
139	20	80	30	90	< 60	≤ 260	≤ 3	≤ 10

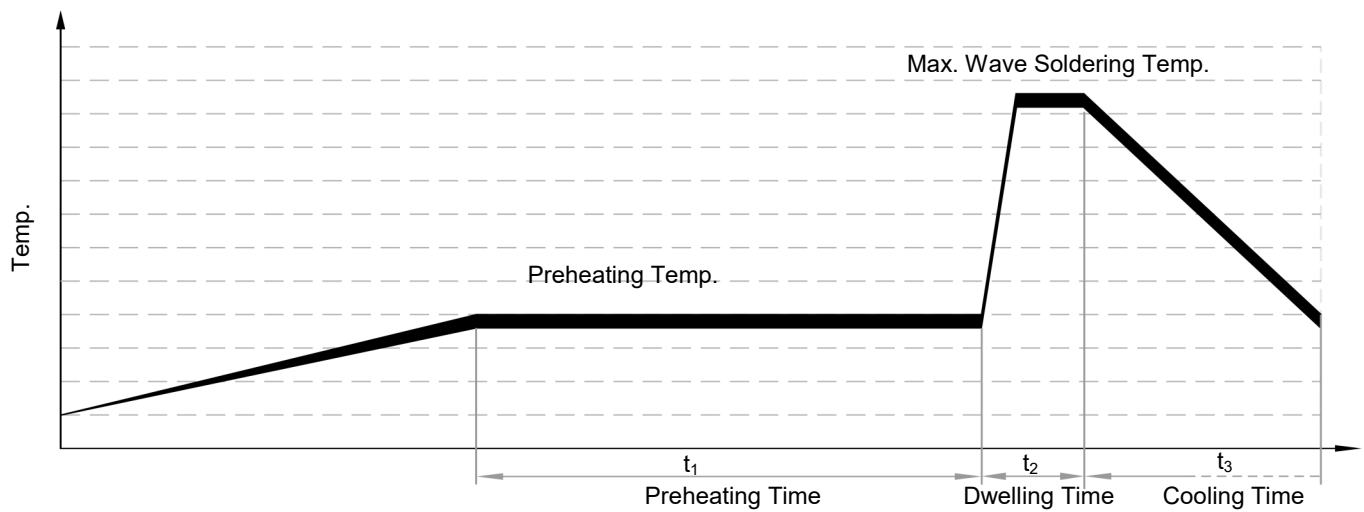

Product Temp.-Time Curve (Reference)

The Temp.-Time Curve of Thermal-Link in different temp. oil bath.

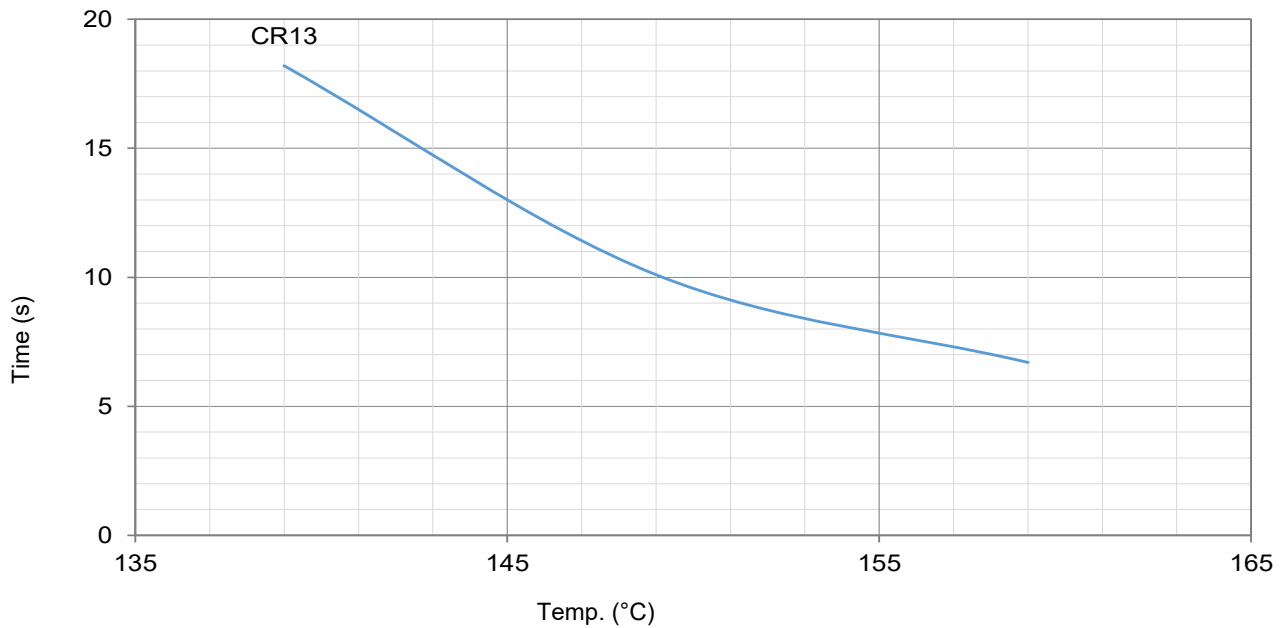

Product Current-Time Curve (Reference)

The Current-Time Curve shows functioning time at multi-times rated current at room temperature $25 \pm 2 \text{ }^\circ\text{C}$.

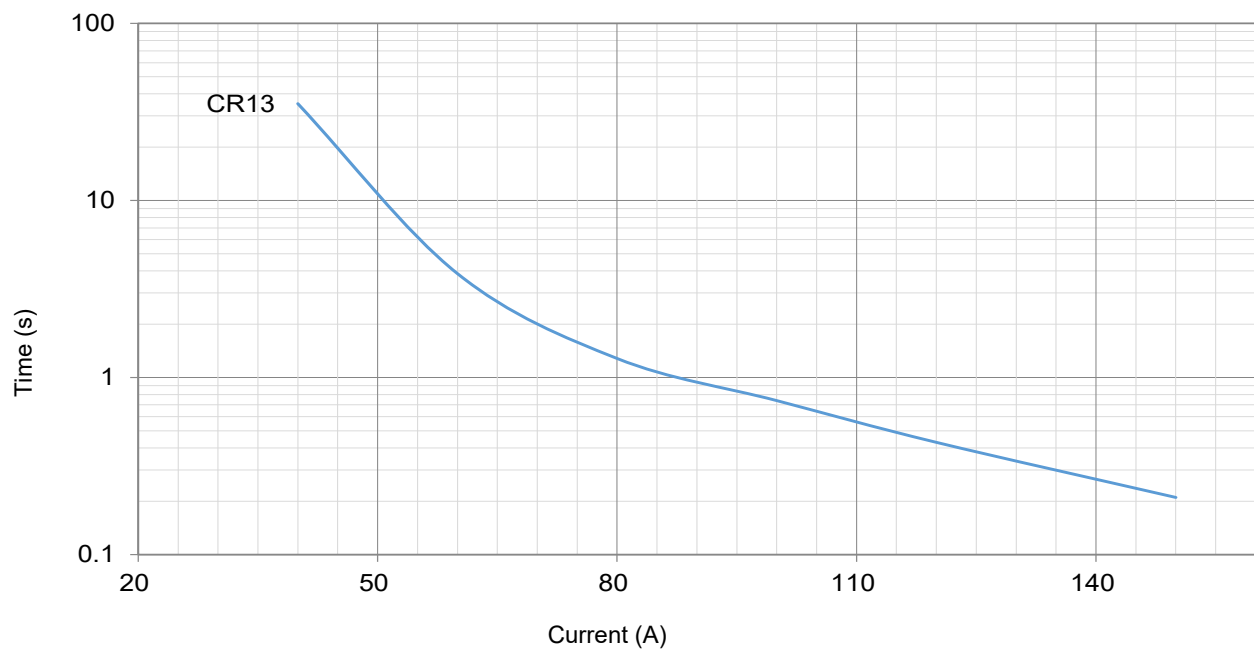

Packaging Information

Bulk

Item	PE Bag	PE Bag	Carton
Dimensions (mm)	135 × 85	190 × 180	440 × 300 × 260
Quantity (PCS)	100	1000	25000
Gross Weight (kg)			16.0 ± 10%

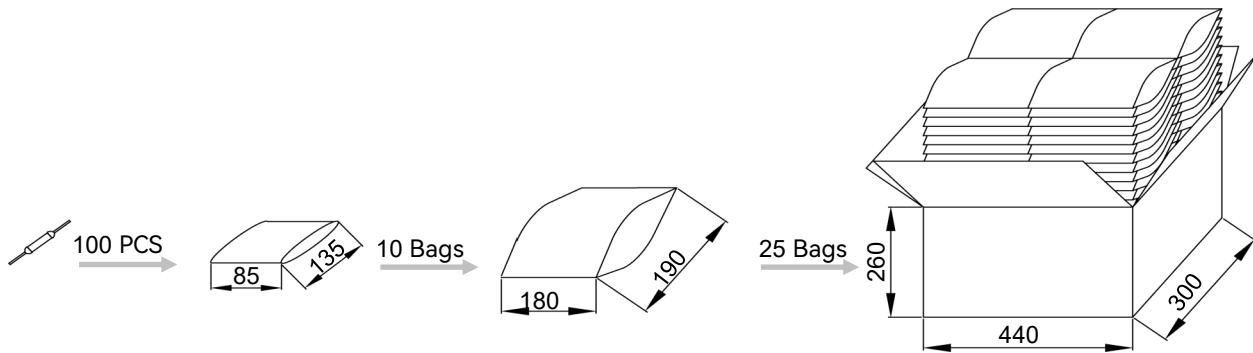

Taping

Item	Scroll	Box	Carton
Dimensions (mm)	Φ 250 × 94	258 × 258 × 98	480 × 300 × 260
Quantity (PCS)	2000	2000	8000
Gross Weight (kg)			12 ± 10%

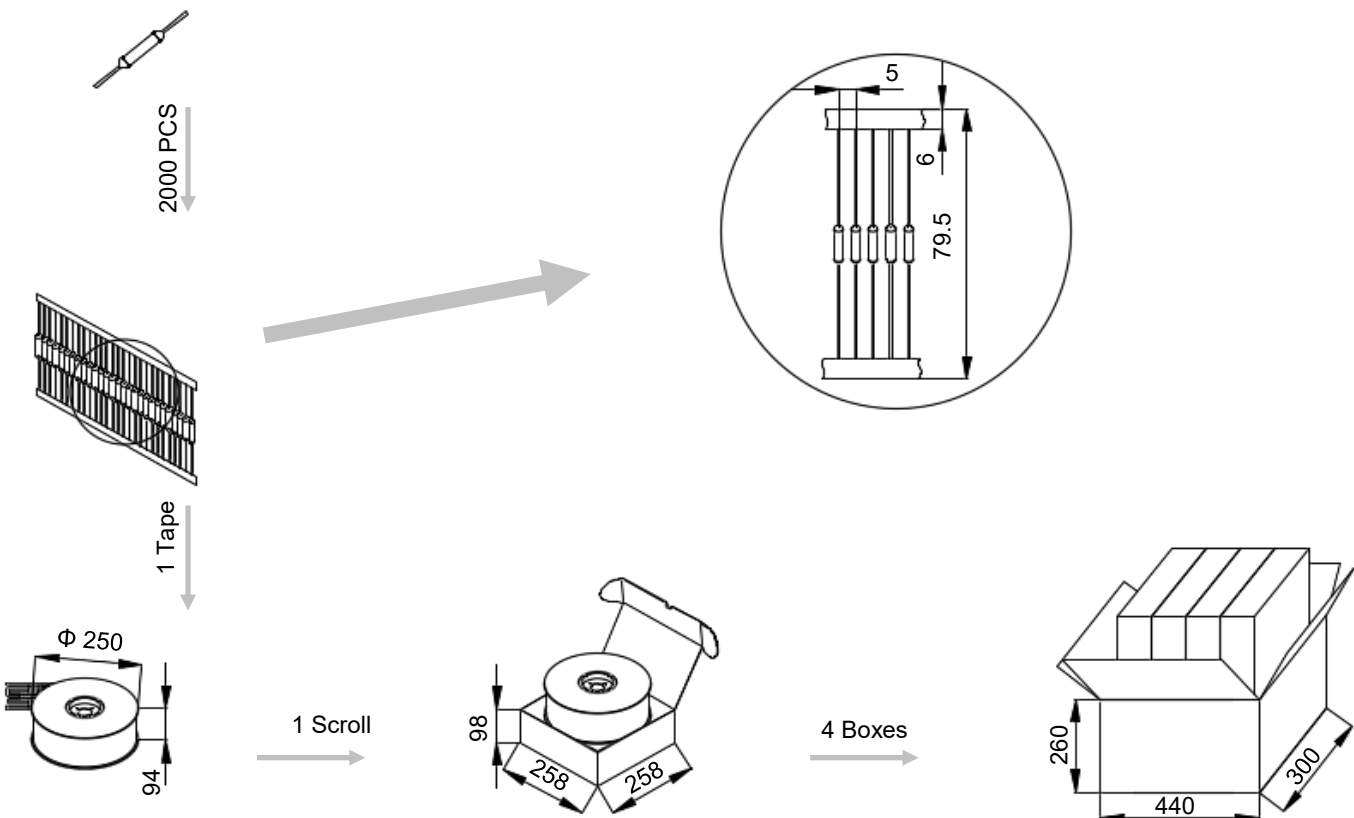

Part Numbering System

ATCO - CR 13 - A N N A B - 001

Other Options

Packing

- B Bulk
- T Taping

Leads Forming

- A Straight Lead
- B Single Lead Bending
- C Leads Bending
- D Leads Kinking
- E Leads Bending and Kinking

Color of Insulation Tube

- W White
- Y Yellow
- R Red
- K Black
- N None

Insulation Tube Material

- T Teflon
- P Polyester
- N None

Lead Wire Type

- A Tinned Copper Wire
- B Tinned Copper Plated Wire

Rated Functioning Temp.

- 13 139 °C, See Specifications

Series

- CR Series
See Specifications

Product Category

ATCO Alloy Thermal-Link

Glossary

Item	Description
TCO	<p>Thermal-Link</p> <p>A non-resettable device incorporating a THERMAL ELEMENT which will open a circuit once only when exposed for a sufficient length of time to a temperature in excess of that for which it has been designed.</p> <p style="text-align: right;">— (GB 9816.1)</p>
ATCO	<p>Alloy Thermal-Link</p> <p>Alloy Type Thermal-Link, Alloy is the thermal element.</p> <p style="text-align: right;">— (GB 9816.1)</p>
T_f	<p>Rated Functioning Temp.</p> <p>The temperature of the Alloy Thermal-Link which causes it to change the state of conductivity with a detection current up to 10 mA as the only load.</p> <p style="text-align: right;">— (GB 9816.1)</p> <p>Tolerance: T_f °C (GB 9816.1, EN 60691, K60691). Tolerance: $T_f \pm 7$ °C (J60691).</p>
Fusing Temp.	<p>Fusing Temp.</p> <p>The temperature of the Alloy Thermal-Link which causes it to change its state of conductivity is measured with silicone oil bath in which the temperature is increased at the rate of 0.5 °C to 1 °C / minute, with a detection current up to 10 mA as the only load.</p> <p style="text-align: right;">— (GB 9816.1)</p>
T_h	<p>Holding Temp.</p> <p>The Maximum temperature at which a Alloy Thermal-Link will not change its state of conductivity when conducting rated current for 168 hours.</p> <p style="text-align: right;">— (GB 9816.1)</p>
T_m	<p>Maximum Temp. Limit</p> <p>The temperature of the Alloy Thermal-Link stated by the manufacturer, up to which the mechanical and electrical properties of the Alloy Thermal-Link having changed its state of conductivity, will not be impaired for a given time.</p> <p style="text-align: right;">— (GB 9816.1)</p>
I_r	<p>Rated Current</p> <p>The current used to classify a Alloy Thermal-Link, which is the Maximum current that Alloy Thermal-Link allows to carry and is able to cut off the circuit safely.</p> <p style="text-align: right;">— (GB 9816.1)</p>
U_r	<p>Rated Voltage</p> <p>The voltage used to classify a Alloy Thermal-Link, which is the Maximum voltage that Alloy Thermal-Link allows to carry and is able to cut off the circuit safely.</p> <p style="text-align: right;">— (GB 9816.1)</p>
I_n	<p>Nominal Discharge Current</p> <p>Being able to withstand 15 peak currents of waveform 8/20 μs to test the product's durability of withstanding pulse current.</p> <p style="text-align: right;">— (UL 1449)</p>
I_{max}	<p>Max. Discharge Current</p> <p>Being able to withstand 1 peak current of waveform 8/20 μs to test max. pulse current that the product can withstand.</p> <p style="text-align: right;">— (UL 1449)</p>



ATTENTION

Usage

1. When atmosphere pressure is from 80 kPa to 106 kPa, the related altitude shall be from 2000 meters to - 500 meters.
2. Operating voltage less than rated voltage of ATCO, operating current less than rated current of ATCO.
3. Do not touch the ATCO body or lead wires directly when power is on, to avoid burn or electric shock.

Replace

ATCO is a non-repairable product. For safety sake, it shall be replaced by an equivalent ATCO from the same manufacturer, and mounted in the same way.

Storage

Do not store the ATCO at the high temp., high humidity or corrosive gas environment, avoid influencing the solder-ability of the lead wires, the product shall be used up within 1 year after receiving the goods.

Installation

Make Sure the Temp. of Installation Position.

1. It is recommended that a dummy ATCO with inbuilt thermo-couple shall be used to determine the proper temp.
2. The terminal product should be tested to ensure that potential abnormal conditions do not cause ambient temp. to exceed the T_m of the ATCO.
3. Mount the ATCO at the location where temp. rises evenly.

Installation position of mechanical performance requirements.

1. Do not locate the ATCO in a place where severe vibration always occurs.
2. Ensure that the lead wire is long enough, and avoid actions such as press, tensile or twist.
3. The seal or body of ATCO must not be damaged, burned or over heated.

Mechanical Connection

Riveting

1. Choose small resistivity riveting material and be riveted.
2. A flexible lead or lead with low resistance should be used to rivet the ATCO.
3. Contact resistance should be minimal, large contact resistance will lead to higher temp., ATCO Functioning in advance.

Crimping

1. Choose small resistivity crimping material and be crimped.
2. A flexible lead or lead with low resistance should be used to rivet the ATCO.
3. Contact resistance should be minimal, large contact resistance will lead to higher Temp., ATCO Functioning in advance.

Lead Wire Forming

1. If lead wire has to be bent, please pay attention to the distance between body and bending point. Refer to Table T-3.
2. When bending leads, please use pincher or similar tools to fix the product as shown in Fig.T-2, to avoid damaging the product.
3. During forming and mounting, lead wire should not be cut, nicked, bent sharply, to avoid breaking the product.
4. Tangential forces on the leads must be avoided (i.e. pushing or pulling on the leads at angle to ATCO body) as such forces may damage the seal of ATCO.

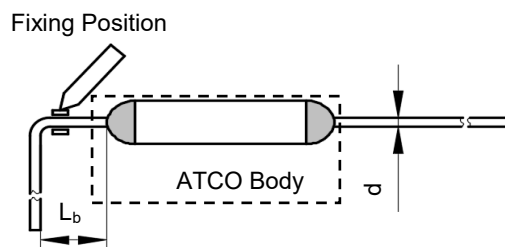

FIGURE T-2

TABLE T-3 Distance between Body and Bending Point

Circular lead	d	(mm)	< 1.0	1.0 - 1.2	> 1.2
	L _b	(mm)	≥ 3	≥ 5	≥ 10

Leads Forming Types

The below leads forming is for reference, more leads forming can be customized.



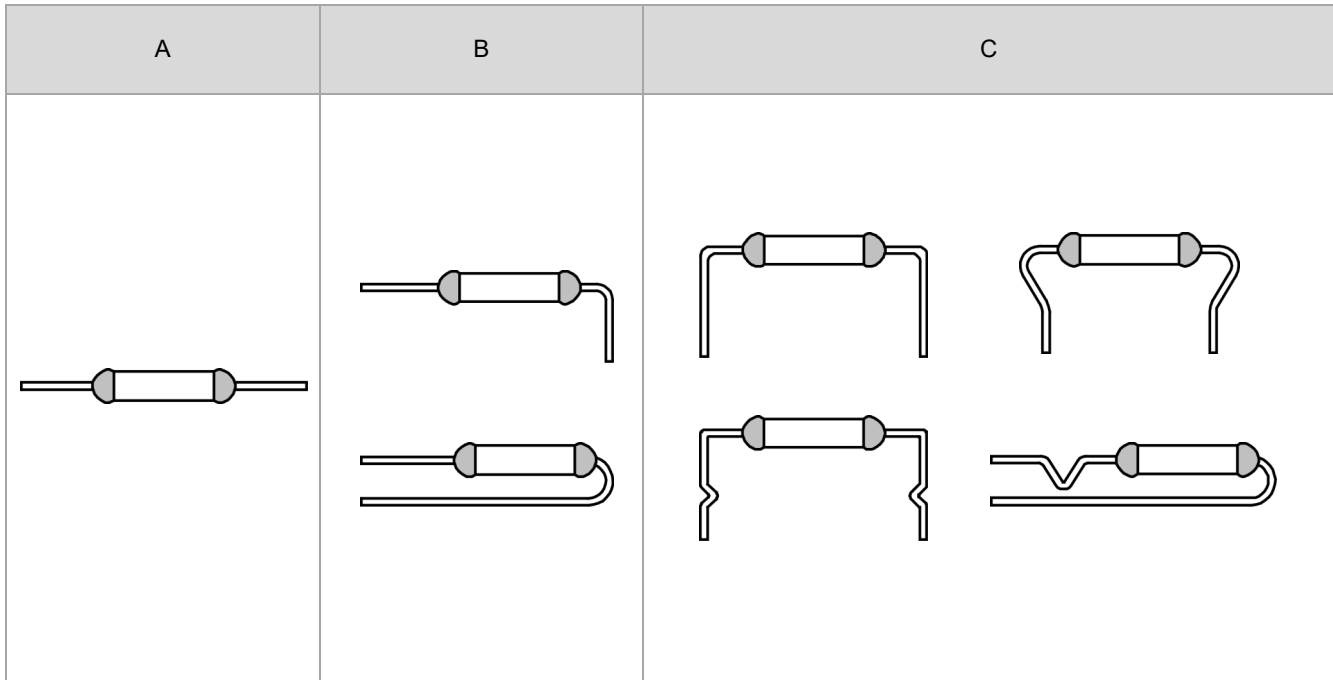

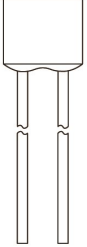
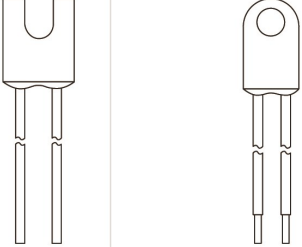

Axial

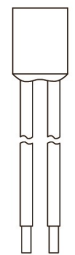
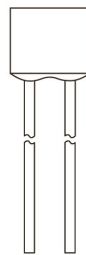

Thermal-Link (ATCO)-Alloy Type Feature & Model List Overview

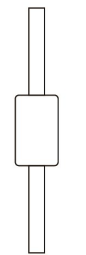
Rated Functioning Temp. (T _r) °C	230	○	○	○	○	○	○	○	○	○	○	○	○	○	○	○	○	○	○	SKL230	SE230	○	Model				
	221	V31	H31	B31	C31	U31	R31	○	K31	X31	○	○	○	○	○	○	○	○	KG31	XG31	SK221	○		○	TK221		
	205	V32	H32	B32	C32	U32	R32	○	K32	X32	○	○	○	○	○	○	○	○	○	KG32	XG32	SK205		○	○	TK205	
	200	○	○	○	○	○	○	○	○	○	○	○	○	○	○	○	○	○	○	○	○	SKL200		SE200	○	○	
	187	○	○	○	○	○	○	○	○	K17	X17	Y17	○	○	○	○	○	○	○	○	○	○		○	○	○	
	160	V16	H16	B16	C16	U16	R16	F16	K16	X16	Y16	○	○	○	○	○	○	○	○	KG16	XG16	SK160		○	○	TK160	
	150	V7	H7	B7	C7	U7	R7	F7	K7	X7	Y7	S150	T150	○	○	N150	G150	KG7	XG7	SK150	○	SE150		TK150	○		
	145	V6	H6	B6	C6	U6	R6	F6	K6	X6	Y6	○	○	○	○	○	○	○	○	KG6	XG6	SK145		○	SE145	TK145	
	139	V13	H13	B13	C13	○	○	○	○	○	○	○	○	○	○	○	○	○	○	○	○	○		○	○	○	○
	136	V9	H9	B9	C9	○	○	○	○	K9	X9	Y9	S136	T136	P136	Q136	N136	G136	KG9	XG9	○	○		○	○	○	
	135	V5	H5	B5	C5	U5	R5	○	K5	X5	○	○	○	○	○	○	○	○	○	KG5	XG5	SK135		○	SE135	TK135	
	133	V8	H8	B8	C8	○	○	○	F8	K8	X8	Y8	○	○	○	○	○	○	○	○	KG8	XG8		○	○	○	○
	130	V4	H4	B4	C4	U4	R4	F4	K4	X4	Y4	○	○	○	○	○	N130	G130	KG4	XG4	SK130	○		○	TK130	○	
	125	V3	H3	B3	C3	U3	R3	F3	K3	X3	Y3	S125	T125	○	○	N125	G125	KG3	XG3	SK125	○	SE125		TK125	○		
	123	○	○	○	○	○	○	○	○	○	○	○	○	○	○	○	○	○	○	○	○	○		○	○	○	○
	120	○	○	○	○	○	○	○	○	○	○	○	○	○	○	○	○	○	○	○	○	○		○	○	○	○
	115	V2	H2	B2	C2	U2	R2	F2	K2	X2	Y2	S115	T115	P115	Q115	N115	G115	KG2	XG2	SK115	○	SE115		TK115	○		
	105	○	○	○	○	○	○	○	○	○	○	○	○	○	○	○	○	○	○	○	○	○		○	○	○	○
	102	V1	H1	B1	C1	U1	R1	F1	K1	X1	Y1	S102	T102	○	○	N102	G102	KG1	XG1	SK102	○	SE102		TK102	○		
	97	V21	H21	B21	C21	○	○	○	○	○	○	○	○	○	○	○	○	○	○	○	○	○		○	○	○	○
95	○	○	○	○	○	○	○	○	○	○	○	○	○	○	○	○	○	○	○	○	○	○	○	○	○		
86	V18	H18	B18	C18	U18	R18	F18	K18	X18	Y18	○	○	○	○	○	○	○	○	KG18	XG18	○	○	○	○	○		
76	V0	H0	B0	C0	U0	R0	F0	K0	X0	Y0	○	○	○	○	○	○	○	○	KG0	XG0	○	○	○	○	○		
I_r (A) Rated Current		1	2	3	5	10	15	1	2	3	5	10	15 16	20	25	30	40	2	3	10	10	10	15	16			
U_r (VAC) Rated Voltage		250																									
Product Structure																											
	Axial Shape						Radial Shape						Radial Shape (Screw Hole)														



Thermal-Link (ATCO)-Alloy Type Feature & Model List Overview

Rated Functioning Temp. (T_r) °C	Model																					
	SY145	TY145	KM7	XM7	Y7	YM7	SM150	TM150		KM7	XM7			HU7	HR7			HC7		HL7	HW7	
230	○	○	○	○	○	○	○	○	○	○	○	○	○	○	○	○	○	○	○	○	○	○
221	○	○	○	○	○	○	○	○	○	○	○	○	○	○	○	○	○	○	○	○	○	○
205	○	○	○	○	○	○	○	○	○	○	○	○	○	○	○	○	○	○	○	○	○	○
200	○	○	○	○	○	○	○	○	○	○	○	○	○	○	○	○	○	○	○	○	○	○
187	○	○	○	○	○	○	○	○	○	○	○	○	○	○	○	○	○	○	○	○	○	○
160	○	○	○	○	○	○	○	○	○	○	○	○	○	○	○	○	○	○	○	○	○	○
150	○	○	KM7	XM7	Y7	YM7	SM150	TM150		KM7	XM7			HU7	HR7			HC7		HL7	HW7	
145	SY145	TY145	○	○	○	○	○	○	○	○	○	○	○	HU6	HR6	HS145	HP145	HC6	HN145	HL6	HW6	
139	○	○	○	○	○	○	○	○	○	○	○	○	○	○	○	○	○	○	○	○	○	○
136	○	○	○	○	Y9	YM9	SM136	TM136	Q136	○	○	P136	Q136	○	○	HS136	HP136	○	HN136	○	○	
135	○	○	KM5	XM5	○	○	○	○	○	KM5	XM5	○	○	HU5	HR5	○	○	HC5	○	HL5	HW5	
133	○	○	○	○	○	○	○	○	○	○	○	○	○	○	○	○	○	○	○	○	○	○
130	SY130	TY130	KM4	XM4	Y4	YM4	○	○	○	KM4	XM4	○	○	HU4	HR4	○	○	○	○	HL4	HW4	
125	SY125	TY125	○	○	○	○	○	○	○	KM3	XM3	P125	Q125	HU3	HR3	HS125	HP125	HC3	HN125	HL3	HW3	
123	○	○	○	○	○	○	○	○	○	○	○	○	○	○	○	○	○	○	○	○	○	○
120	SY120	TY120	○	○	○	○	○	○	○	○	○	○	○	○	○	○	○	○	○	○	○	○
115	SY115	TY115	○	○	○	○	SM115	TM115	Q115	○	○	P115	Q115	HU2	HR2	○	○	HC2	○	HL2	HW2	
105	SY105	TY105	○	○	○	○	○	○	○	○	○	○	○	○	○	○	○	○	○	○	○	○
102	○	○	○	○	○	○	SM102	TM102	○	○	○	P102	Q102	HU1	HR1	○	○	HC1	○	HL1	HW1	
97	○	○	○	○	○	○	○	○	○	○	○	○	○	○	○	○	○	○	○	○	○	○
95	SY95	TY95	○	○	○	○	○	○	○	○	○	○	○	○	○	○	○	○	○	○	○	○
86	○	○	○	○	○	○	○	○	○	○	○	○	○	HU18	HR18	○	○	HC18	○	HL18	HW18	
76	○	○	○	○	○	○	○	○	○	○	○	○	○	HU0	HR0	○	○	HC0	○	HL0	HW0	
I_r (A) Rated Current	10	15	2	3	5	5	10	15 16	25	2	3	20	25	10	15	5	10	5	15	10	15	
U_r (VAC) Rated Voltage	250		300						320		400		500				690		800			
Product Structure																						
	Cylindrical		Radial Shape						Axial Shape		Axial Shape (Flat Electrode)		Axial Shape		Axial Shape (Flat Electrode)		Axial Shape					

Thermal-Link (ATCO)-Alloy Type Feature & Model List Overview

Rated Functioning Temp. (T_r) °C	Model																																																																											
	V0	H0	B0	C0				V18						C18			U0	R0																																																										
230	○	○	○	○	○	○	○	○	○	○	○	○	○	○	○	○	○	○	○																																																									
221	○	○	○	○	○	V31	H31	○	B31	○	○	○	○	C31	○	○	○	○	U31	R31	○																																																							
205	○	○	○	○	○	V32	H32	○	B32	○	○	○	○	C32	○	○	○	○	U32	R32	○																																																							
200	○	○	○	○	○	○	○	○	○	○	○	○	○	○	○	○	○	○	○	○	○																																																							
187	○	○	○	○	○	○	○	○	○	○	○	○	○	○	○	○	○	○	○	○	○																																																							
160	○	○	○	○	○	V16	H16	○	B16	○	○	○	○	C16	○	○	○	○	U16	R16	○																																																							
150	V7	H7	B7	○	C7	○	○	○	○	○	○	○	○	○	○	○	○	○	U7	R7	○																																																							
145	V6	H6	B6	○	C6	○	○	○	○	○	○	○	○	○	○	○	C6	U6	R6	○	○																																																							
139	V13	H13	B13	○	C13	○	○	○	○	○	SF13	V13	○	○	○	C13	M13	○	○	○	CR13																																																							
136	V9	H9	B9	○	C9	○	○	○	○	○	○	○	○	○	○	○	○	○	○	○	○																																																							
135	V5	H5	B5	○	C5	○	○	○	○	○	○	○	○	○	○	○	○	○	U5	R5	○																																																							
133	V8	H8	B8	○	C8	○	○	○	○	○	SF8	○	V8	○	○	○	○	○	○	○	○																																																							
130	V4	H4	B4	○	C4	○	○	○	○	○	SF4	○	V4	○	○	○	○	○	U4	R4	○																																																							
125	V3	○	B3	○	C3	○	H3	○	○	○	○	○	○	○	○	○	○	○	U3	R3	○																																																							
123	○	○	○	○	○	○	○	○	○	○	○	○	○	○	○	○	○	○	○	○	○																																																							
120	○	○	○	○	○	○	○	○	○	○	○	○	○	○	○	○	○	○	○	○	○																																																							
115	V2	H2	B2	○	C2	○	○	○	○	○	SF2	○	V2	○	○	C2	○	○	U2	R2	○																																																							
105	○	○	○	○	○	○	○	○	○	○	○	○	○	○	○	○	○	○	○	○	○																																																							
102	V1	H1	B1	C1	○	○	○	○	○	○	○	○	○	○	○	○	○	○	U1	R1	○																																																							
97	V21	H21	B21	C21	○	○	○	○	○	○	○	○	○	○	○	○	○	○	○	○	○																																																							
95	○	○	○	○	○	○	○	○	○	○	○	○	○	○	○	○	○	○	○	○	○																																																							
86	V18	H18	B18	C18	○	○	○	V18	○	○	○	○	○	C18	○	○	○	○	U18	R18	○																																																							
76	V0	H0	B0	C0	○	○	○	○	○	○	○	○	○	○	○	○	○	○	U0	R0	○																																																							
Product Structure	<p>Axial Shape</p>																																																																											
	<table border="1"> <thead> <tr> <th>I_r (A) Rated Current</th> <th colspan="4">50</th> <th colspan="14">60</th> </tr> <tr> <th>U_r (VDC) Rated Voltage</th> <th colspan="4">50</th> <th colspan="14">60</th> </tr> </thead> <tbody> <tr> <td>1</td><td>2</td><td>3</td><td>5</td><td>7</td> <td>1</td><td>2</td><td>2.5</td><td>3</td><td>3</td><td>5</td><td>4</td><td>5</td><td>6</td><td>8</td><td>8.5</td><td>9</td><td>10</td><td>10</td><td>15</td><td>15</td> </tr> </tbody> </table>																		I_r (A) Rated Current	50				60														U_r (VDC) Rated Voltage	50				60														1	2	3	5	7	1	2	2.5	3	3	5	4	5	6	8	8.5	9	10	10	15
I_r (A) Rated Current	50				60																																																																							
U_r (VDC) Rated Voltage	50				60																																																																							
1	2	3	5	7	1	2	2.5	3	3	5	4	5	6	8	8.5	9	10	10	15	15																																																								

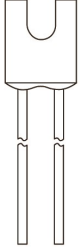
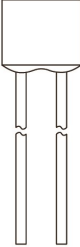
Thermal-Link (ATCO)-Alloy Type Feature & Model List Overview

Rated Functioning Temp. (T_f) °C	Model																	
	KG3	XG3	K3	X3	F3	X6	S150	T150	P150	Q150	SD150	TD150	PD150	QD150	HS150	HP150	HN150	
230	○	○	○	○	○	○	○	○	○	○	○	○	○	○	○	○	○	○
221	○	○	○	○	○	○	○	○	○	○	○	○	○	○	○	○	○	○
205	○	○	○	○	○	○	○	○	○	○	○	○	○	○	○	○	○	○
200	○	○	○	○	○	○	○	○	○	○	○	○	○	○	○	○	○	○
187	○	○	○	○	○	○	○	○	○	○	○	○	○	○	○	○	○	○
160	○	○	○	○	○	○	○	○	○	○	○	○	○	○	○	○	○	○
150	○	○	○	○	○	○	○	○	○	○	○	○	○	○	○	○	○	○
145	○	○	○	○	○	F6	X6	○	○	○	○	○	○	○	○	○	○	○
139	○	○	○	○	○	F13	○	○	○	○	○	○	○	○	○	○	○	○
136	○	○	○	○	○	○	X9	S136	T136	P136	Q136	SD136	TD136	PD136	QD136	HS136	HP136	HN136
135	○	○	○	○	○	○	○	○	○	○	○	○	○	○	○	○	○	○
133	○	○	○	○	○	F8	○	○	○	○	○	○	○	○	○	○	○	○
130	○	○	○	○	○	F4	○	○	○	○	○	○	○	○	○	○	○	○
125	KG3	XG3	K3	X3	○	○	○	S125	T125	P125	Q125	SD125	TD125	PD125	QD125	HS125	HP125	HN125
123	○	○	○	○	○	○	○	○	○	○	○	○	○	○	○	○	○	○
120	○	○	○	○	○	○	○	○	○	○	○	○	○	○	○	○	○	○
115	KG2	XG2	K2	X2	F2	○	○	S115	T115	P115	Q115	SD115	TD115	PD115	QD115	○	○	○
105	○	○	○	○	○	○	○	○	○	○	○	○	○	○	○	○	○	○
102	KG1	XG1	K1	X1	F1	○	○	S102	T102	P102	Q102	SD102	TD102	PD102	QD102	○	○	○
97	○	○	○	○	○	○	○	○	○	○	○	○	○	○	○	○	○	○
95	○	○	○	○	○	○	○	○	○	○	○	○	○	○	○	○	○	○
86	KG18	XG18	K18	X18	F18	○	○	○	○	○	○	○	○	○	○	○	○	○
76	○	○	○	○	○	○	○	○	○	○	○	○	○	○	○	○	○	○
I_r (A) Rated Current	2	3	2	3	3	4	10	15 16	20	25	10	15 16	20	25	5	10	15	
U_r (VDC) Rated Voltage	60						100		120		125				200			
Product Structure																		
	Radial Shape (Screw Hole)						Radial Shape						Axial Shape (Flat Electrode)					